



深圳市百康光电有限公司

Bicom Optics

规格书 SPECIFICATION

品 名

Description: LED Lens

型 号

Part No.: BK-LED-809C

材 料

Material: PC

Made by: Ann

透 镜 规 格

Lens Spec.

产品型号 Part Number	产品图片 Picture	产品尺寸 Dimension	适配 LED 种类 LED type	角度 Angle
BK-LED-809C		直径 Dia: $\Phi 45\text{mm}$ 高度 Height: 35.1mm	SAMSUNG HV-DC WA4	38.2°

尺寸图 Drawing

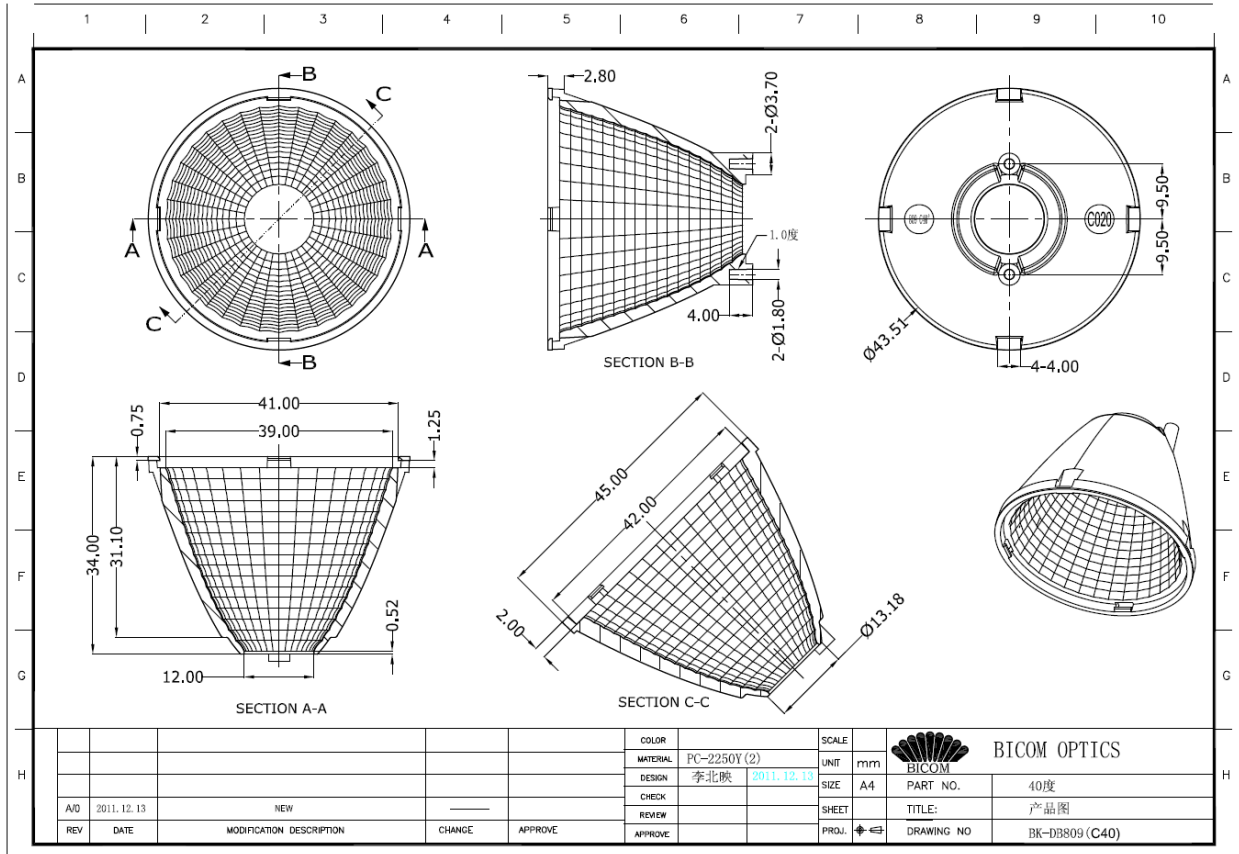



光学检验报告

Optical Test Report

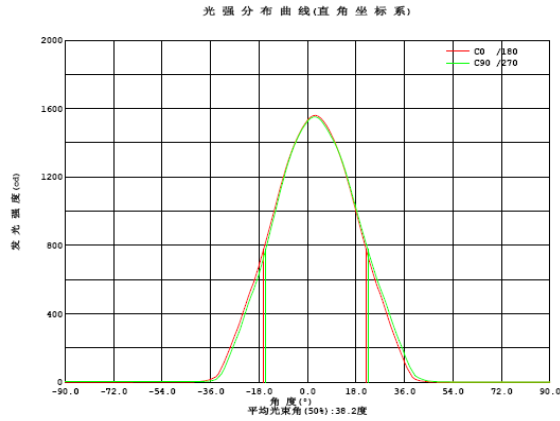
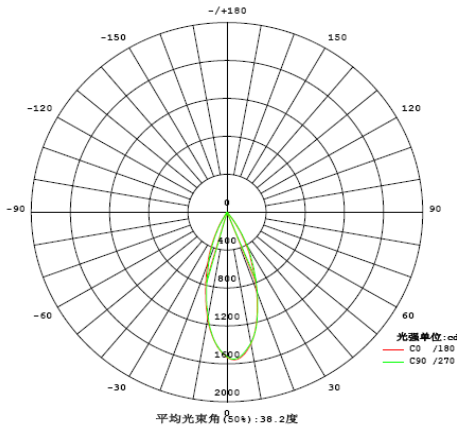

光强分布数据:(角度°, 光强cd) C0 /180

角度	光强	角度	光强	角度	光强	角度	光强	角度	光强	角度	光强
-90.0	1.105	-58.0	1.735	-26.0	313.0	6.0	1524	38.0	55.44	70.0	0.9312
-88.0	1.161	-56.0	1.754	-24.0	403.9	8.0	1474	40.0	17.25	72.0	0.9022
-86.0	1.216	-54.0	1.775	-22.0	499.2	10.0	1409	42.0	7.061	74.0	0.8627
-84.0	1.265	-52.0	1.799	-20.0	582.7	12.0	1328	44.0	3.661	76.0	0.8253
-82.0	1.321	-50.0	1.831	-18.0	683.7	14.0	1230	46.0	2.203	78.0	0.7916
-80.0	1.369	-48.0	1.870	-16.0	792.5	16.0	1118	48.0	1.526	80.0	0.7559
-78.0	1.417	-46.0	1.938	-14.0	908.0	18.0	998.5	50.0	1.321	82.0	0.7163
-76.0	1.465	-44.0	2.167	-12.0	1024	20.0	880.5	52.0	1.249	84.0	0.6788
-74.0	1.508	-42.0	2.828	-10.0	1143	22.0	761.4	54.0	1.203	86.0	0.6384
-72.0	1.548	-40.0	4.129	-8.0	1252	24.0	653.7	56.0	1.166	88.0	0.5988
-70.0	1.593	-38.0	7.913	-6.0	1345	26.0	556.3	58.0	1.131	90.0	0.5538
-68.0	1.622	-36.0	15.88	-4.0	1422	28.0	469.5	60.0	1.097		
-66.0	1.650	-34.0	31.30	-2.0	1484	30.0	370.7	62.0	1.065		
-64.0	1.674	-32.0	80.77	0.0	1531	32.0	280.5	64.0	1.032		
-62.0	1.693	-30.0	152.9	2.0	1557	34.0	198.0	66.0	0.9976		
-60.0	1.713	-28.0	232.5	4.0	1555	36.0	117.7	68.0	0.9668		

电学参数:

工作电压: 35.40 V 工作电流: 0.3500 A
 电功率: 12.39 W 功率因数: 1.000

光学参数(测试距离:5.980m):

总光通量: $\Phi_t = 88.62 \text{ lm}$ 光效: $\text{Eff} = 7.15 \text{ lm/W}$

平均光强扩散角: $\theta(25\%): 54.3^\circ$ $\theta(50\%): 38.2^\circ$ $\theta(75\%): 24.9^\circ$ $\theta(10\%): 65.4^\circ$

C0 /180: $\theta(25\%): 54.2^\circ$ $\theta(50\%): 38.2^\circ$ $\theta(75\%): 24.9^\circ$ $\theta(10\%): 65.3^\circ$

C0 /180 $I_{\text{max}} = 1560 \text{ cd}$ ($G=3.0^\circ$) $I_0 = 1531 \text{ cd}$

H(β) 角度范围:-90度 - 90度
 H(β) 角度间隔: 0.5度
 测试速度: 快速
 环境温度: 25.3°C
 测试人员:
 测试日期: 2012-02-16

V(β) 角度范围:-90度 - 90度
 V(β) 角度间隔: 0.5度
 测试系统: 远方(EVERFINE)GO-2000B_V1系统 V2.0.263
 环境湿度: 65.0%
 测试距离: 5.980米 [K=1.0000]
 备注:



光学检验报告

Optical Test Report

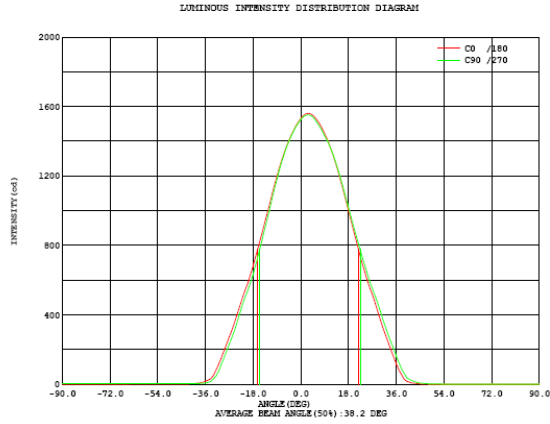
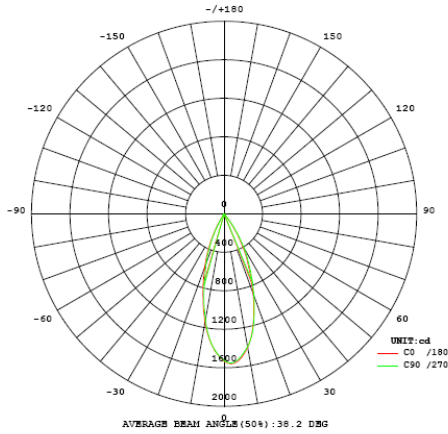

Intensity data:(deg , cd) C0 /180

A	I	A	I	A	I	A	I	A	I	A	I
-90.0	1.105	-58.0	1.735	-26.0	313.0	6.0	1524	38.0	55.44	70.0	0.9312
-88.0	1.161	-56.0	1.754	-24.0	403.9	8.0	1474	40.0	17.25	72.0	0.9022
-86.0	1.216	-54.0	1.775	-22.0	499.2	10.0	1409	42.0	7.061	74.0	0.8627
-84.0	1.265	-52.0	1.799	-20.0	582.7	12.0	1328	44.0	3.661	76.0	0.8253
-82.0	1.321	-50.0	1.831	-18.0	683.7	14.0	1230	46.0	2.203	78.0	0.7916
-80.0	1.369	-48.0	1.870	-16.0	792.5	16.0	1118	48.0	1.526	80.0	0.7559
-78.0	1.417	-46.0	1.938	-14.0	908.0	18.0	998.5	50.0	1.321	82.0	0.7163
-76.0	1.465	-44.0	2.167	-12.0	1024	20.0	880.5	52.0	1.249	84.0	0.6788
-74.0	1.508	-42.0	2.828	-10.0	1143	22.0	761.4	54.0	1.203	86.0	0.6384
-72.0	1.548	-40.0	4.129	-8.0	1252	24.0	653.7	56.0	1.166	88.0	0.5988
-70.0	1.593	-38.0	7.913	-6.0	1345	26.0	556.3	58.0	1.131	90.0	0.5538
-68.0	1.622	-36.0	15.88	-4.0	1422	28.0	469.5	60.0	1.097		
-66.0	1.650	-34.0	31.30	-2.0	1484	30.0	370.7	62.0	1.065		
-64.0	1.674	-32.0	80.77	0.0	1531	32.0	280.5	64.0	1.032		
-62.0	1.693	-30.0	152.9	2.0	1557	34.0	198.0	66.0	0.9976		
-60.0	1.713	-28.0	232.5	4.0	1555	36.0	117.7	68.0	0.9668		

Electricity Parameter:

Voltage : 35.40 V Current : 0.3500 A
 Power P: 12.39 W Power Factor: 1.000

Optical Parameter (Distance:5.980m) :

Luminous flux = 88.62 lm Efficiency: Eff=7.15 lm/W
 Avg. Beam angle: @ (25%):54.3deg @ (50%):38.2deg @ (75%):24.9deg @ (10%):65.4deg
 C0 /180: @ (25%):54.2deg @ (50%):38.2deg @ (75%):24.9deg @ (10%):65.3deg
 C0 /180 Imax = 1560 cd (G=3.0deg) Io = 1531 cd

H(β) Range:-90 - 90DEG
 H(β) Interval: 0.5DEG
 Test Speed: HIGH
 Temperature:25.3DEG
 Operators:
 Test Date:2012-02-16

V(B) Range:-90 - 90DEG
 V(B) Interval: 0.5DEG
 Test System:EVERFINE GO-2000B_V1 SYSTEM V2.0.263
 Humidity:65.0%
 Test Distance:5.980m [K=1.0000]
 Remarks:



光学检验报告

Optical Test Report

灯具光度数据

灯具名称: BK-DB809C	灯具类型:	灯具重量:/
外型尺寸:	灯具规格:	测试编号:
制造厂商:	发光口面:	保护角:/

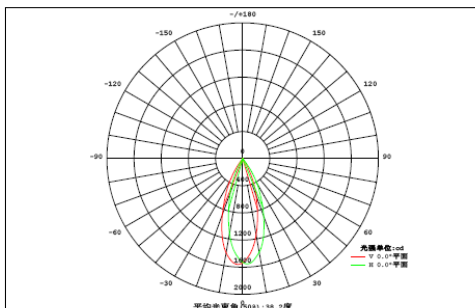

光源数据		光度数据	
型号	HV-DC WA4	峰值光强(cd)	1591
标称功率(W)	7	有效效率(%)	80.9
额定电源电压(V)	35.4	有效光通(lm)	670.0
额定光通量(lm)	828.00	灯具效率(%)	85.6
灯具内光源数(只)	1	总光通量(lm)	708.5
实测电源电压(V)	35.4	50%光束角(H,V)	38°, 38°

垂直角度V(°)	区域光通量																单位:lm		φ总	φ有
	0.00	0.01	0.01	0.01	0.02	0.02	0.03	0.03	0.04	0.04	0.04	0.04	0.03	0.03	0.02	0.02	0.01	0.00		
90	0.00	0.00	0.01	0.01	0.02	0.02	0.03	0.03	0.04	0.04	0.04	0.04	0.03	0.03	0.02	0.02	0.01	0.00	0.39	0.00
80	0.00	0.01	0.01	0.01	0.02	0.03	0.03	0.04	0.04	0.05	0.04	0.04	0.04	0.03	0.02	0.02	0.01	0.00	0.44	0.00
70	0.00	0.01	0.01	0.02	0.02	0.03	0.03	0.04	0.04	0.05	0.04	0.04	0.04	0.03	0.03	0.02	0.01	0.00	0.45	0.00
60	0.00	0.01	0.01	0.02	0.02	0.03	0.03	0.04	0.05	0.05	0.05	0.04	0.04	0.03	0.03	0.02	0.01	0.00	0.47	0.00
50	0.00	0.01	0.01	0.02	0.02	0.03	0.07	0.19	0.33	0.28	0.13	0.05	0.04	0.03	0.03	0.02	0.01	0.00	1.26	0.00
40	0.00	0.01	0.01	0.02	0.03	0.11	1.21	4.00	6.16	5.31	2.30	0.36	0.05	0.03	0.03	0.02	0.01	0.00	19.7	12.6
30	0.00	0.01	0.01	0.02	0.04	0.94	6.98	14.9	19.4	17.6	10.4	2.87	0.21	0.04	0.03	0.02	0.01	0.00	73.5	69.7
	0.00	0.01	0.01	0.02	0.09	2.91	13.5	27.2	35.3	31.4	19.4	7.55	0.76	0.05	0.03	0.02	0.01	0.00	138	135
	0.00	0.01	0.01	0.02	0.12	4.25	16.9	34.0	45.5	40.4	24.9	10.2	1.16	0.05	0.03	0.02	0.01	0.00	178	175
	0.00	0.01	0.01	0.02	0.09	3.60	15.2	30.6	41.0	36.8	22.4	8.80	0.85	0.05	0.03	0.02	0.01	0.00	160	157
	0.00	0.01	0.01	0.02	0.05	1.56	9.35	19.2	25.1	22.3	13.3	4.25	0.28	0.05	0.04	0.02	0.01	0.00	95.6	92.3
	0.00	0.01	0.02	0.02	0.03	0.22	2.62	7.49	10.1	8.59	4.04	0.63	0.08	0.05	0.04	0.03	0.01	0.00	34.0	27.8
-30	0.00	0.01	0.02	0.02	0.03	0.05	0.15	0.69	0.98	0.63	0.22	0.09	0.07	0.06	0.04	0.03	0.01	0.00	3.10	0.00
-40	0.00	0.01	0.02	0.03	0.04	0.04	0.06	0.07	0.09	0.09	0.09	0.09	0.08	0.06	0.04	0.03	0.01	0.00	0.84	0.00
-50	0.00	0.01	0.02	0.03	0.04	0.05	0.06	0.08	0.09	0.09	0.09	0.09	0.08	0.07	0.05	0.03	0.01	0.00	0.88	0.00
-60	0.00	0.01	0.02	0.03	0.04	0.05	0.07	0.08	0.09	0.10	0.10	0.09	0.08	0.07	0.05	0.03	0.01	0.00	0.91	0.00
-70	0.00	0.01	0.02	0.03	0.04	0.05	0.07	0.08	0.10	0.10	0.10	0.09	0.08	0.06	0.04	0.03	0.01	0.00	0.90	0.00
-80	0.00	0.01	0.02	0.03	0.04	0.05	0.06	0.08	0.09	0.09	0.09	0.08	0.07	0.06	0.04	0.03	0.01	0.00	0.82	0.00
-90	0.00	0.01	0.01	0.02	0.03	0.05	0.06	0.08	0.09	0.09	0.09	0.08	0.07	0.06	0.04	0.03	0.01	0.00	0.82	0.00
	-90	-80	-70	-60	-50	-40	-30	-20	横向角度H(°)	20	30	40	50	60	70	80	90			
φ总	0.03	0.12	0.24	0.37	0.76	14.0	66.4	139	185	164	97.8	35.4	4.02	0.85	0.61	0.41	0.22	0.06	709	---
φ有	0.00	0.00	0.00	0.00	0.00	8.14	62.2	135	181	160	93.7	29.6	0.00	0.00	0.00	0.00	0.00	0.00	---	670

H(β) 角度范围: -90度 - 90度
H(β) 角度间隔: 0.5度
测试速度: 快速
环境温度: 25.3℃
测试人员:
测试日期: 2012-02-16

V(B) 角度范围: -90度 - 90度
V(B) 角度间隔: 0.5度
测试系统: 远方(EVERFINE)GO-2000B_V1系统 V2.0.263
环境湿度: 65.0%
测试距离: 5.980米 [K=1.0000]
备注:



光学检验报告

Optical Test Report

LUMINAIRE PHOTOMETRIC TEST REPORT

NAME: BK-DB809C	TYPE:	WEIGHT: /
DIMENSION:	SPECIFICATION:	SERIAL No.:
MANUFACTURER:	SURFACE:	PROTECTION ANGLE: /

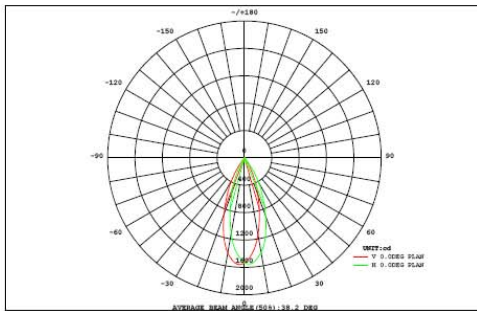

DATA OF LAMP		PHOTOMETRIC DATA	
MODEL	HV-DC WA4	Imax (cd)	1591
NOMINAL POWER (W)	7	AVAILABILITY (%)	80.9
RATED VOLTAGE (V)	35.4	Avai. FLUX (lm)	670.0
NOMINAL FLUX (lm)	828.00	EFFICIENCY (%)	85.6
LAMPS INSIDE	1	TOTAL FLUX (lm)	708.5
TEST VOLTAGE (V)	35.4	θ @50% (H,V)	38,38DEG

VERTICAL (DEG)	AREA FLUX DIAGRAM																UNIT: lm		Φt	Φa
	90	80	70	60	50	40	30	20	10	0	10	20	30	40	50	60	70	80		
90	0.00	0.00	0.01	0.01	0.02	0.02	0.03	0.03	0.04	0.04	0.04	0.04	0.03	0.03	0.02	0.02	0.01	0.00	0.39	0.00
80	0.00	0.01	0.01	0.01	0.02	0.03	0.03	0.04	0.04	0.05	0.04	0.04	0.04	0.03	0.02	0.02	0.01	0.00	0.44	0.00
70	0.00	0.01	0.01	0.02	0.02	0.03	0.03	0.04	0.04	0.05	0.04	0.04	0.04	0.03	0.03	0.02	0.01	0.00	0.45	0.00
60	0.00	0.01	0.01	0.02	0.02	0.03	0.03	0.04	0.05	0.05	0.05	0.04	0.04	0.03	0.03	0.02	0.01	0.00	0.47	0.00
50	0.00	0.01	0.01	0.02	0.02	0.03	0.07	0.19	0.33	0.28	0.13	0.05	0.04	0.03	0.03	0.02	0.01	0.00	1.26	0.00
40	0.00	0.01	0.01	0.02	0.03	0.11	1.21	4.00	6.16	5.31	2.30	0.36	0.05	0.03	0.03	0.02	0.01	0.00	19.7	12.6
30	0.00	0.01	0.01	0.02	0.04	0.94	6.98	14.9	19.4	17.6	10.4	2.87	0.21	0.04	0.03	0.02	0.01	0.00	73.5	69.7
20	0.00	0.01	0.01	0.02	0.09	2.91	13.5	27.2	35.3	31.4	19.4	7.55	0.76	0.05	0.03	0.02	0.01	0.00	138	135
10	0.00	0.01	0.01	0.02	0.12	4.25	16.9	34.0	45.5	40.4	24.9	10.2	1.16	0.05	0.03	0.02	0.01	0.00	178	175
0	0.00	0.01	0.01	0.02	0.09	3.60	15.2	30.6	41.0	36.8	22.4	8.80	0.85	0.05	0.03	0.02	0.01	0.00	160	157
-10	0.00	0.01	0.01	0.02	0.05	1.56	9.35	19.2	25.1	22.3	13.3	4.25	0.28	0.05	0.04	0.02	0.01	0.00	95.6	92.3
-20	0.00	0.01	0.02	0.02	0.03	0.22	2.62	7.49	10.1	8.59	4.04	0.63	0.08	0.05	0.04	0.03	0.01	0.00	34.0	27.8
-30	0.00	0.01	0.02	0.02	0.03	0.05	0.15	0.69	0.98	0.63	0.22	0.09	0.07	0.06	0.04	0.03	0.01	0.00	3.10	0.00
-40	0.00	0.01	0.02	0.03	0.04	0.04	0.06	0.07	0.09	0.09	0.09	0.08	0.08	0.06	0.04	0.03	0.01	0.00	0.84	0.00
-50	0.00	0.01	0.02	0.03	0.04	0.05	0.06	0.08	0.09	0.09	0.09	0.09	0.08	0.07	0.05	0.03	0.01	0.00	0.88	0.00
-60	0.00	0.01	0.02	0.03	0.04	0.05	0.07	0.08	0.09	0.10	0.10	0.09	0.08	0.07	0.05	0.03	0.01	0.00	0.91	0.00
-70	0.00	0.01	0.02	0.03	0.04	0.05	0.07	0.08	0.10	0.10	0.10	0.09	0.08	0.06	0.04	0.03	0.01	0.00	0.90	0.00
-80	0.00	0.01	0.02	0.03	0.04	0.05	0.07	0.08	0.10	0.10	0.10	0.09	0.08	0.06	0.04	0.03	0.01	0.00	0.90	0.00
-90	0.00	0.01	0.01	0.02	0.03	0.05	0.06	0.08	0.09	0.09	0.09	0.08	0.07	0.06	0.04	0.03	0.01	0.00	0.82	0.00
	-90	-80	-70	-60	-50	-40	-30	-20	HORIZONTAL (DEG)	20	30	40	50	60	70	80	90			
Φt	0.03	0.12	0.24	0.37	0.76	14.0	66.4	139	185	164	97.8	35.4	4.02	0.85	0.61	0.41	0.22	0.06	709	---
Φa	0.00	0.00	0.00	0.00	0.00	8.14	62.2	135	181	160	93.7	29.6	0.00	0.00	0.00	0.00	0.00	0.00	---	670

H(β) Range:-90 - 90DEG
H(β) Interval: 0.5DEG
Test Speed: HIGH
Temperature:25.3DEG
Operators:
Test Date:2012-02-16

V(B) Range:-90 - 90DEG
V(B) Interval: 0.5DEG
Test System:EVERFINE GO-2000B_V1 SYSTEM V2.0.263
Humidity:65.0%
Test Distance:5.980m [K=1.0000]
Remarks: