



深圳市百康光电有限公司

Bicom Optics

规格书 SPECIFICATION

品 名

Description: LED Lens

型 号

Part No.: BK-LED-850A

材 料

Material: PC

Made by: Ann

透 镜 规 格

Lens Spec.

产品型号 Part Number	产品图片 Picture	产品尺寸 Dimension	适配 LED 种类 LED type	角度 Angle
BK-LED-850A		直径 Dia: $\Phi 45\text{mm}$ 高度 Height: 20mm	CITIZEN CL-L030	30.2°



尺寸图
Drawing

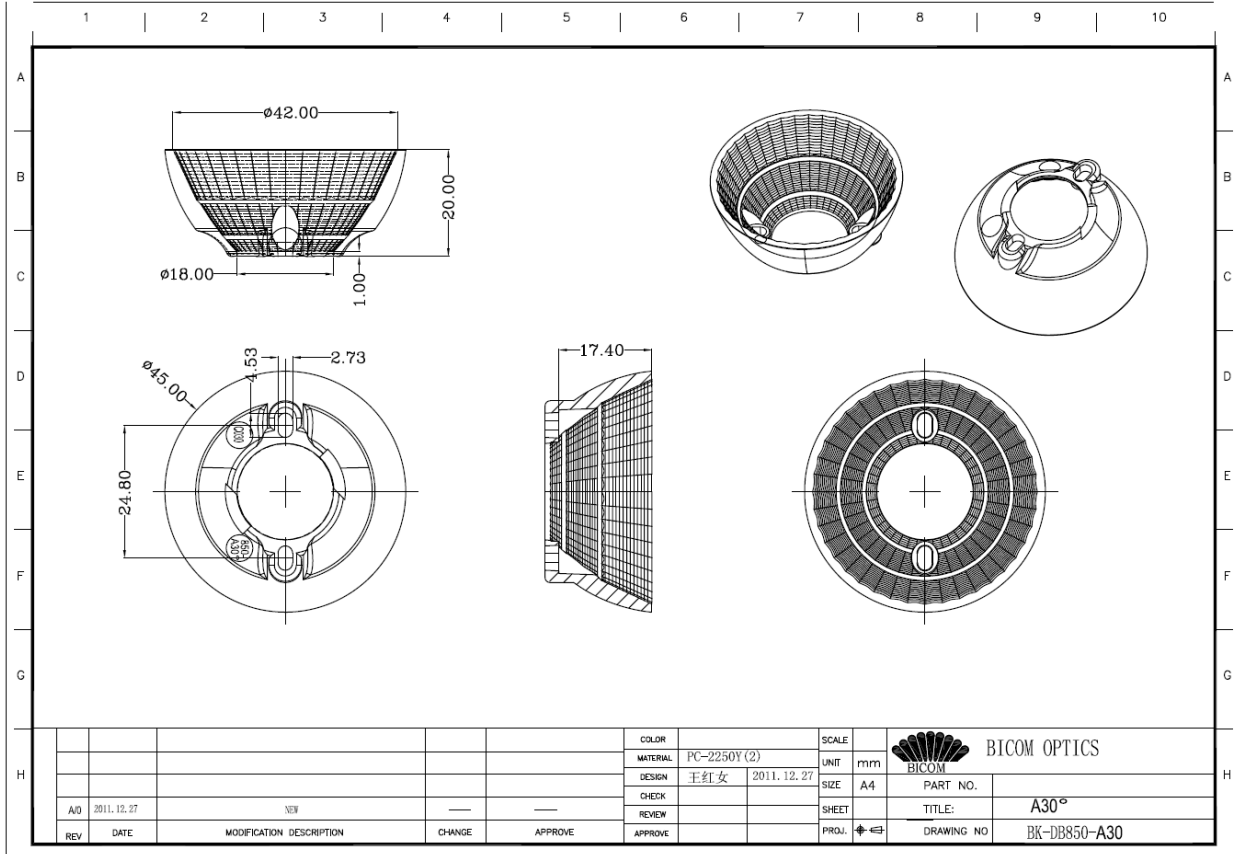



光学检验报告

Optical Test Report

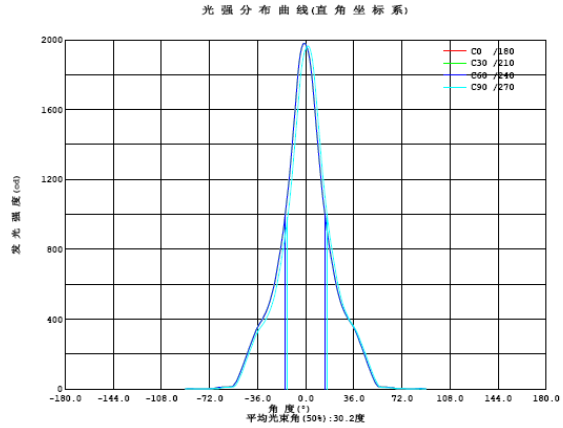
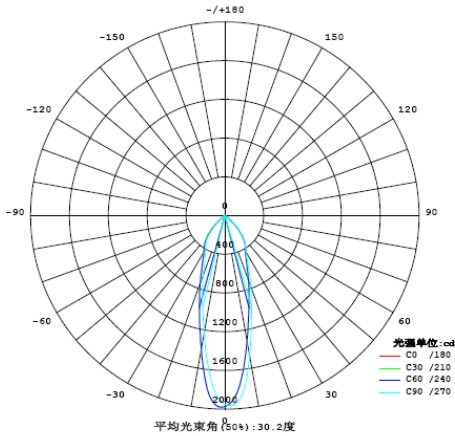

光强分布数据: (角度°, 光强cd) C0 /180

角度	光强	角度	光强	角度	光强	角度	光强	角度	光强	角度	光强
-90.0	0.3178	-58.0	11.55	-26.0	522.7	6.0	1676	38.0	317.5	70.0	2.153
-88.0	2.328	-56.0	12.24	-24.0	582.6	8.0	1496	40.0	279.0	72.0	1.886
-86.0	2.077	-54.0	18.63	-22.0	658.9	10.0	1319	42.0	237.8	74.0	1.705
-84.0	1.440	-52.0	41.45	-20.0	747.5	12.0	1157	44.0	195.6	76.0	1.527
-82.0	1.227	-50.0	75.23	-18.0	844.0	14.0	1022	46.0	152.7	78.0	1.464
-80.0	1.266	-48.0	112.8	-16.0	952.1	16.0	903.6	48.0	110.6	80.0	1.425
-78.0	1.292	-46.0	154.1	-14.0	1086	18.0	801.2	50.0	71.61	82.0	1.512
-76.0	1.381	-44.0	195.9	-12.0	1232	20.0	710.8	52.0	37.80	84.0	2.174
-74.0	1.510	-42.0	238.5	-10.0	1406	22.0	628.1	54.0	15.62	86.0	2.838
-72.0	1.682	-40.0	279.7	-8.0	1595	24.0	558.0	56.0	11.95	88.0	2.279
-70.0	2.047	-38.0	318.7	-6.0	1785	26.0	500.0	58.0	10.77	90.0	0.1291
-68.0	4.349	-36.0	353.9	-4.0	1916	28.0	458.8	60.0	10.26		
-66.0	8.033	-34.0	379.9	-2.0	1975	30.0	426.3	62.0	9.565		
-64.0	9.674	-32.0	404.6	0.0	1973	32.0	399.8	64.0	8.572		
-62.0	10.37	-30.0	436.2	2.0	1930	34.0	376.5	66.0	5.902		
-60.0	10.88	-28.0	474.3	4.0	1830	36.0	351.7	68.0	2.855		

电学参数:

工作电压: 40.00 V 工作电流: 0.3500 A
 电功率: 14.00 W 功率因数: 1.000

光学参数(测试距离: 5.980m):

总光通量: $\Phi_t = 83.61 \text{ lm}$ 光效: $\text{Eff} = 5.97 \text{ lm/W}$

平均光强扩散角: $\theta(25\%): 53.9^\circ$ $\theta(50\%): 30.2^\circ$ $\theta(75\%): 17.5^\circ$ $\theta(10\%): 88.7^\circ$

C0 /180: $\theta(25\%): 54.1^\circ$ $\theta(50\%): 30.2^\circ$ $\theta(75\%): 17.5^\circ$ $\theta(10\%): 88.7^\circ$

C0 /180 $I_{\text{max}} = 1979 \text{ cd}$ ($G = -1.0^\circ$) $I_0 = 1973 \text{ cd}$

H(β) 角度范围: -90度 - 90度
 H(β) 角度间隔: 0.5度
 测试速度: 快速
 环境温度: 25.3°C
 测试人员:
 测试日期: 2012-07-19

V(β) 角度范围: -90度 - 90度
 V(β) 角度间隔: 0.5度
 测试系统: 远方(EVERFINE)GO-2000B_V1系统 V2.0.263
 环境湿度: 65.0%
 测试距离: 5.980米 [K=1.0000]
 备注:



光学检验报告

Optical Test Report

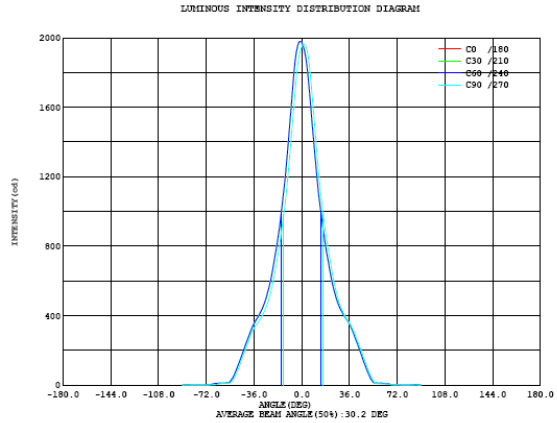
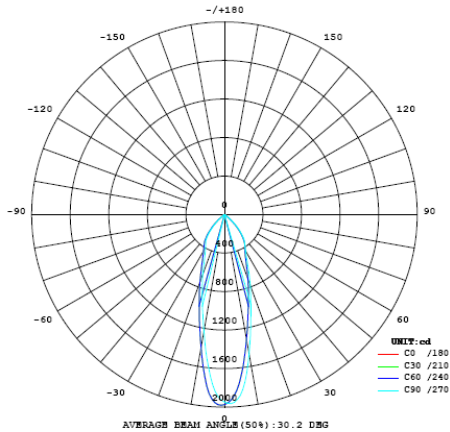

Intensity data:(deg , cd) C0 /180

A	I	A	I	A	I	A	I	A	I	A	I
-90.0	0.3178	-58.0	11.55	-26.0	522.7	6.0	1676	38.0	317.5	70.0	2.153
-88.0	2.328	-56.0	12.24	-24.0	582.6	8.0	1496	40.0	279.0	72.0	1.886
-86.0	2.077	-54.0	18.63	-22.0	658.9	10.0	1319	42.0	237.8	74.0	1.705
-84.0	1.440	-52.0	41.45	-20.0	747.5	12.0	1157	44.0	195.6	76.0	1.527
-82.0	1.227	-50.0	75.23	-18.0	844.0	14.0	1022	46.0	152.7	78.0	1.464
-80.0	1.266	-48.0	112.8	-16.0	952.1	16.0	903.6	48.0	110.6	80.0	1.425
-78.0	1.292	-46.0	154.1	-14.0	1086	18.0	801.2	50.0	71.61	82.0	1.512
-76.0	1.381	-44.0	195.9	-12.0	1232	20.0	710.8	52.0	37.80	84.0	2.174
-74.0	1.510	-42.0	238.5	-10.0	1406	22.0	628.1	54.0	15.62	86.0	2.838
-72.0	1.682	-40.0	279.7	-8.0	1595	24.0	558.0	56.0	11.95	88.0	2.279
-70.0	2.047	-38.0	318.7	-6.0	1785	26.0	500.0	58.0	10.77	90.0	0.1291
-68.0	4.349	-36.0	353.9	-4.0	1916	28.0	458.8	60.0	10.26		
-66.0	8.033	-34.0	379.9	-2.0	1975	30.0	426.3	62.0	9.565		
-64.0	9.674	-32.0	404.6	0.0	1973	32.0	399.8	64.0	8.572		
-62.0	10.37	-30.0	436.2	2.0	1930	34.0	376.5	66.0	5.902		
-60.0	10.88	-28.0	474.3	4.0	1830	36.0	351.7	68.0	2.855		

Electricity Parameter:

Voltage : 40.00 V Current : 0.3500 A
 Power P: 14.00 W Power Factor: 1.000

Optical Parameter (Distance: 5.980m) :

Luminous flux = 83.61 lm Efficiency: Eff=5.97 lm/W
 Avg. Beam angle: @ (25%):53.9deg @ (50%):30.2deg @ (75%):17.5deg @ (10%):88.7deg
 C0 /180: @ (25%):54.1deg @ (50%):30.2deg @ (75%):17.5deg @ (10%):88.7deg
 C0 /180 I_{max} = 1979 cd (G=-1.0deg) I_o = 1973 cd

H(β) Range:-90 - 90DEG
 H(β) Interval: 0.5DEG
 Test Speed: HIGH
 Temperature:25.3DEG
 Operators:
 Test Date:2012-07-19

V(B) Range:-90 - 90DEG
 V(B) Interval: 0.5DEG
 Test System:EVERFINE GO-2000B_V1 SYSTEM V2.0.263
 Humidity:65.0%
 Test Distance:5.980m [K=1.0000]
 Remarks:



光学检验报告

Optical Test Report

灯具光度数据

灯具名称: DB850A	灯具类型:	灯具重量:/
外型尺寸:	灯具规格:	测试编号:
制造厂商:	发光口面:	保护角:/

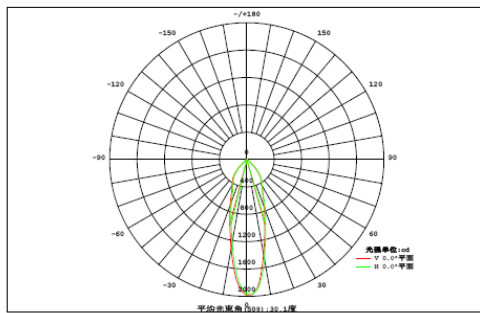

光源数据		光度数据	
型号	CLL030	峰值光强(cd)	1979
标称功率(W)	14	有效效率(%)	80.8
额定电源电压(V)	40	有效光通(lm)	969.7
额定光通量(lm)	1200.0	灯具效率(%)	88.7
灯具内光源数(只)	1	总光通量(lm)	1065
实测电源电压(V)	40	50%光束角(H, V)	30°, 30°

垂直角度V(°)	区域光通量																		单位:lm		Φ总	Φ有
	0.00	0.01	0.02	0.03	0.04	0.04	0.04	0.04	0.04	0.04	0.04	0.04	0.04	0.03	0.03	0.02	0.01	0.00				
90	0.00	0.01	0.02	0.03	0.04	0.04	0.04	0.04	0.04	0.04	0.04	0.04	0.04	0.03	0.03	0.02	0.01	0.00	0.50	0.00		
80	0.00	0.02	0.02	0.03	0.03	0.04	0.04	0.05	0.05	0.05	0.05	0.04	0.04	0.03	0.02	0.02	0.02	0.00	0.55	0.00		
70	0.01	0.02	0.02	0.03	0.04	0.06	0.10	0.13	0.15	0.15	0.14	0.11	0.07	0.04	0.03	0.02	0.01	0.01	1.12	0.00		
60	0.01	0.01	0.02	0.04	0.11	0.19	0.28	0.53	0.82	0.83	0.54	0.29	0.21	0.12	0.04	0.02	0.01	0.01	4.07	0.00		
50	0.01	0.01	0.02	0.09	0.20	0.66	2.36	4.39	5.67	5.67	4.41	2.39	0.68	0.21	0.11	0.02	0.01	0.00	26.9	10.1		
40	0.01	0.01	0.04	0.15	0.55	3.11	6.74	9.53	11.0	11.0	9.54	6.75	3.14	0.58	0.16	0.04	0.01	0.00	62.3	53.6		
30	0.01	0.01	0.06	0.19	1.73	6.01	10.1	13.6	16.9	17.0	13.7	10.2	6.03	1.78	0.20	0.07	0.01	0.00	97.6	91.6		
	0.01	0.01	0.08	0.29	3.00	7.98	12.6	20.6	30.1	30.4	21.1	12.8	8.01	3.04	0.32	0.09	0.01	0.00	150	145		
	0.01	0.01	0.09	0.40	3.71	8.87	14.6	27.6	48.2	49.5	28.8	15.2	8.94	3.74	0.43	0.10	0.01	0.00	210	206		
	0.01	0.01	0.09	0.39	3.65	8.80	14.4	26.6	45.0	46.3	27.9	14.9	8.87	3.69	0.43	0.10	0.01	0.00	201	197		
	0.01	0.01	0.08	0.27	2.86	7.78	12.1	18.9	26.3	26.6	19.4	12.4	7.81	2.89	0.30	0.09	0.01	0.00	138	133		
	0.01	0.01	0.06	0.19	1.54	5.64	9.66	12.6	14.9	14.9	12.7	9.71	5.66	1.58	0.20	0.07	0.01	0.00	89.5	83.1		
-30	0.01	0.01	0.03	0.15	0.45	2.66	6.07	8.76	10.00	10.0	8.77	6.09	2.70	0.48	0.16	0.04	0.01	0.00	56.4	46.7		
-40	0.01	0.01	0.02	0.09	0.20	0.49	1.76	3.45	4.46	4.47	3.47	1.79	0.52	0.21	0.10	0.02	0.01	0.00	21.1	4.38		
-50	0.01	0.01	0.02	0.04	0.10	0.19	0.27	0.37	0.50	0.51	0.38	0.28	0.20	0.11	0.04	0.02	0.01	0.01	3.06	0.00		
-60	0.01	0.02	0.02	0.03	0.04	0.05	0.08	0.11	0.13	0.13	0.12	0.09	0.06	0.03	0.02	0.02	0.01	0.01	0.97	0.00		
-70	0.00	0.02	0.02	0.03	0.03	0.03	0.04	0.04	0.04	0.04	0.04	0.04	0.03	0.03	0.02	0.02	0.02	0.00	0.50	0.00		
-80	0.00	0.01	0.02	0.03	0.03	0.03	0.03	0.03	0.03	0.03	0.03	0.03	0.03	0.03	0.02	0.02	0.01	0.00	0.44	0.00		
-90	0.00	0.00	0.00	0.00	0.00	0.00	0.00	0.00	0.00	0.00	0.00	0.00	0.00	0.00	0.00	0.00	0.00	0.00	0.00	0.00		
Φ总	0.09	0.24	0.73	2.45	18.3	52.7	91.3	147	214	218	151	93.1	53.0	18.6	2.64	0.80	0.21	0.08	1065	---		
Φ有	0.00	0.00	0.00	0.00	5.49	43.5	83.6	140	207	211	144	85.3	43.8	5.55	0.00	0.00	0.00	0.00	---	970		

H(β) 角度范围: -90度 - 90度
H(β) 角度间隔: 0.5度
测试速度: 快速
环境温度: 25.3℃
测试人员:
测试日期: 2012-07-19

V(B) 角度范围: -90度 - 90度
V(B) 角度间隔: 0.5度
测试系统: 远方(EVERFINE)GO-2000B_V1系统 V2.0.263
环境湿度: 65.0%
测试距离: 5.980米 [K=1.0000]
备注:



光学检验报告

Optical Test Report

LUMINAIRE PHOTOMETRIC TEST REPORT

NAME: DB850A	TYPE:	WEIGHT: /
DIMENSION:	SPECIFICATION:	SERIAL No.:
MANUFACTURER:	SURFACE:	PROTECTION ANGLE: /

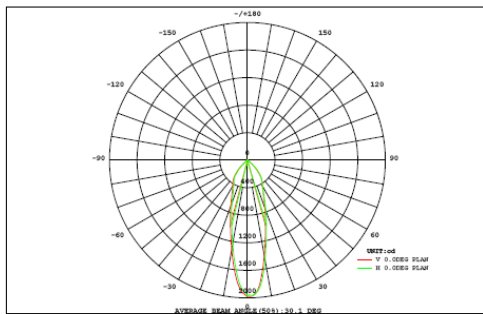

DATA OF LAMP		PHOTOMETRIC DATA	
MODEL	CLL030	Imax (cd)	1979
NOMINAL POWER(W)	14	AVAILABILITY (%)	80.8
RATED VOLTAGE (V)	40	Avai. FLUX (lm)	969.7
NOMINAL FLUX (lm)	1200.0	EFFICIENCY (%)	88.7
LAMPS INSIDE	1	TOTAL FLUX (lm)	1065
TEST VOLTAGE (V)	40	θ @50% (H,V)	30,30DEG

VERTICAL (DEG)	AREA FLUX DIAGRAM																UNIT: lm		Φ t	Φ a
	0.00	0.01	0.02	0.03	0.04	0.04	0.04	0.04	0.04	0.04	0.04	0.04	0.03	0.03	0.02	0.01	0.00			
90	0.00	0.01	0.02	0.03	0.04	0.04	0.04	0.04	0.04	0.04	0.04	0.04	0.03	0.03	0.02	0.01	0.00	0.50	0.00	
80	0.00	0.02	0.02	0.03	0.03	0.04	0.04	0.05	0.05	0.05	0.05	0.04	0.04	0.03	0.02	0.02	0.00	0.55	0.00	
70	0.01	0.02	0.02	0.03	0.04	0.06	0.10	0.13	0.15	0.15	0.14	0.11	0.07	0.04	0.03	0.02	0.01	1.12	0.00	
60	0.01	0.01	0.02	0.04	0.11	0.19	0.28	0.53	0.82	0.83	0.54	0.29	0.21	0.12	0.04	0.02	0.01	4.07	0.00	
50	0.01	0.01	0.02	0.09	0.20	0.66	2.36	4.39	5.67	5.67	4.41	2.39	0.68	0.21	0.11	0.02	0.01	26.9	10.1	
40	0.01	0.01	0.04	0.15	0.55	3.11	6.74	9.53	11.0	11.0	9.54	6.75	3.14	0.58	0.16	0.04	0.01	62.3	53.6	
30	0.01	0.01	0.06	0.19	1.73	6.01	10.1	13.6	16.9	17.0	13.7	10.2	6.03	1.78	0.20	0.07	0.01	97.6	91.6	
	0.01	0.01	0.08	0.29	3.00	7.98	12.6	20.6	30.1	30.4	21.1	12.8	8.01	3.04	0.32	0.09	0.01	150	145	
	0.01	0.01	0.09	0.40	3.71	8.87	14.6	27.6	48.2	49.5	28.8	15.2	8.94	3.74	0.43	0.10	0.01	210	206	
	0.01	0.01	0.09	0.39	3.65	8.80	14.4	26.6	45.0	46.3	27.9	14.9	8.87	3.69	0.43	0.10	0.01	201	197	
	0.01	0.01	0.08	0.27	2.86	7.78	12.1	18.9	26.3	26.6	19.4	12.4	7.81	2.89	0.30	0.09	0.01	138	133	
-30	0.01	0.01	0.06	0.19	1.54	5.64	9.66	12.6	14.9	14.9	12.7	9.71	5.66	1.58	0.20	0.07	0.01	89.5	83.1	
-40	0.01	0.01	0.03	0.15	0.45	2.66	6.07	8.76	10.00	10.0	8.77	6.09	2.70	0.48	0.16	0.04	0.01	56.4	46.7	
-50	0.01	0.01	0.02	0.09	0.20	0.49	1.76	3.45	4.46	4.47	3.47	1.79	0.52	0.21	0.10	0.02	0.01	21.1	4.38	
-60	0.01	0.01	0.02	0.04	0.10	0.19	0.27	0.37	0.50	0.51	0.38	0.28	0.20	0.11	0.04	0.02	0.01	3.06	0.00	
-70	0.01	0.02	0.02	0.03	0.04	0.05	0.08	0.11	0.13	0.13	0.12	0.09	0.06	0.03	0.02	0.02	0.01	0.97	0.00	
-80	0.00	0.02	0.02	0.03	0.03	0.03	0.04	0.04	0.04	0.04	0.04	0.04	0.03	0.03	0.02	0.02	0.02	0.00	0.50	0.00
-90	0.00	0.01	0.02	0.03	0.03	0.03	0.03	0.03	0.03	0.03	0.03	0.03	0.03	0.03	0.02	0.02	0.01	0.00	0.44	0.00
	-90	-80	-70	-60	-50	-40	-30	-20	HORIZONTAL (DEG)	20	30	40	50	60	70	80	90			
Φ t	0.09	0.24	0.73	2.45	18.3	52.7	91.3	147	214	218	151	93.1	53.0	18.6	2.64	0.80	0.21	0.08	1065	---
Φ a	0.00	0.00	0.00	0.00	5.49	43.5	83.6	140	207	211	144	85.3	43.8	5.55	0.00	0.00	0.00	0.00	---	970

H(β) Range:-90 - 90DEG
H(β) Interval: 0.5DEG
Test Speed: HIGH
Temperature:25.3DEG
Operators:
Test Date:2012-07-19

V(B) Range:-90 - 90DEG
V(B) Interval: 0.5DEG
Test System:EVERFINE GO-2000B_V1 SYSTEM V2.0.263
Humidity:65.0%
Test Distance:5.980m [K=1.0000]
Remarks: